

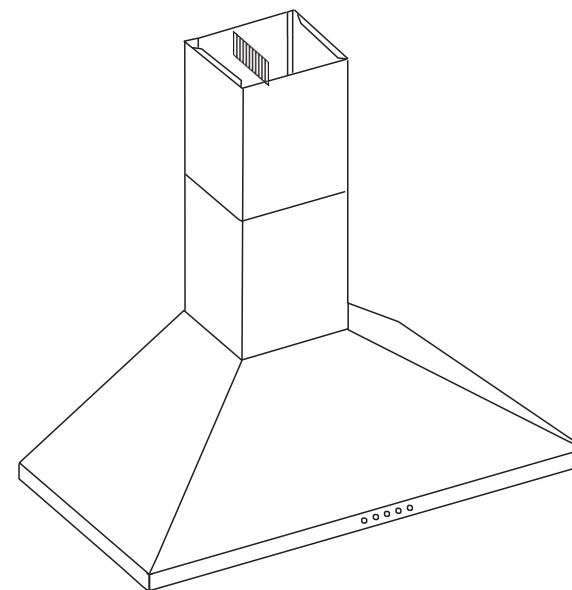

BOURDEAU
PROFESSIONAL KITCHEN®

RANGE HOOD

INSTRUCTION MANUAL



READ AND SAVE THESE INSTRUCTIONS

Dear Customer,

If you follow the recommendations contained in this Instruction Manual, our appliance will give you constant high performance and will remain efficient for many years to come.

CONTENTS

RECOMMENDATIONS AND SUGGESTIONS

CHARACTERISTICS

INSTALLATION & USE

MAINTENANCE

RECOMMENDATIONS AND SUGGESTIONS

INSTALLATION

- * The manufacturer will not be held liable for any damages resulting from incorrect or improper installation.
- * Please read this instruction manual before installing and using this range hood. Properly keep this instruction manual in a safe place for future reference.
- * This range hood can be used either in the Ducted Mode (ducting fumes to the outside) or in the Recirculation Mode (internal recycling). The choice of modes can be left to customers.
- * Only a qualified and trained service technician can undertake the work of installation, and services.
- * Check that the mains voltage corresponds to the one indicated on the rating plate fixed inside the hood.
- * Check that the domestic power supply guarantees adequate earthing.
- * Do not connect the hood to exhaust ducts carrying combustion fumes (boilers, fireplaces, etc.)
- * If the hood is used in conjunction with non-electrical appliances (e. g. gas burning appliances), a sufficient degree of aeration must be guaranteed in the room in order to prevent the backflow of exhaust gas. The kitchen must have an opening directly with the open air in order to guarantee the entry of clean air.
- * The minimum distance is 30 inches from the range hood to a gas hob, and is 25

inches to an electric hob. If the installation instructions for gas hobs specify a greater distance, this must be taken into account.

NOTICE: Considering excessive weight, two or more people are required to install or move this appliance. Failure to do so can cause physical injuries.

- * The range hood has been designed only for domestic use to eliminate kitchen fumes.
- * Never use the hood for purposes other than what it has been designed for.
- * Never leave high naked flames under the hood when it is in operation.
- * Adjust the flame intensity to direct it onto the bottom of the pan only; making sure that it does not engulf the pan sides.
- * Deep fat fryer must be continuously monitored during use: overheated oil can burst into flame.
- * The hood should not be used by children or person not instructed in its correct use.

MAINTENANCE

- * Proper maintenance of the Range Hood will assure proper performance of the unit.
- * Disconnect the hood from the main supply before carrying out any maintenance work.
- * Clean and/or replace aluminum grease filters and activated charcoal filters after specified period of time.
- * Clean the hood using a damp cloth and a neutral liquid detergent.
- * **DISPOSAL:** Do not dispose this product as unsorted municipal waste. Collection of such waste separately for special treatment is necessary.

WARNING!!

In certain circumstances electrical appliances may be a danger hazard.

- * Do not check the status of the filters while the range hood is operating.
- * Do not touch the light bulbs after appliance use.
- * Do not disconnect the appliance with wet hands.
- * Avoid free flame, as it is damaging for the filters and a fire hazard.
- * Constantly check food frying to avoid that the overheated oil may become a fire hazard.

- * Disconnect the electrical plug prior to any maintenance.
- * Children don't recognize the risks of electrical appliances. Therefore use or keep the appliance only under supervision of adults and out of the reach from children.
- * Don't use this product outdoor.
- * This appliance is not intended for use by persons (including children) with reduced physical, sensory or mental capabilities, or lack of experience and knowledge, unless they have been given supervision or instruction concerning use of the appliance by a person responsible for their safety. Children should be supervised to ensure that they do not play with the appliance.
- * There shall be adequate ventilation of the room when the range hood is used at the same time as appliances burning gas or other fuels.
- * There is a fire risk if cleaning is not carried out in accordance with instructions.
- * Do not flambe under the range hood.
- * The discharge air must not be discharged into a flue which is used for exhausting fumes from appliances burning gas or other fuels.
- * **WARNING - To Reduce the Risk Of Fire Or Electric Shock, Do Not Use This Fan With Any Solid-State Speed Control Device.**
- ***WARNING-TO REDUCE THE RISK OF FIRE, USE ONLY METAL DUCTWORK.**
WARNING: TO PROVIDE PROTECTION AGAINST ELECTRIC SHOCK, CONNECT TO PROPERLY GROUNDED OUTLETS ONLY.
- * **WARNING - TO REDUCE THE RISK OF A RANGE TOP GREASE FIRE:**
 - a) Never leave surface units unattended at high settings. Boil overs cause smoking and greasy spillovers that may ignite. Heat oils slowly on low or medium settings.
 - b) Always turn hood ON when cooking at high heat or when flaming food (i.e. Crepes Suzette, Cherries Jubilee, Peppercorn Beef Flambe').
 - c) Clean ventilating fans frequently. Grease should not be allowed to accumulate on fan or filter.
 - d) Use proper pan size. Always use cookware appropriate for the size of the surface element.
- * **WARNING - TO REDUCE THE RISK OF INJURY TO PERSONS IN THE EVENT OF A RANGE TOP GREASE FIRE, OBSERVE THE FOLLOWING:**
 - a) **SMOTHER FLAMES** with a close-fitting lid, cookie sheet, or metal tray, then turn off the burner. **BE CAREFUL TO PREVENT BURNS.** If the flames do not go out immediately, **EVACUATE AND CALL THE FIRE DEPARTMENT.**

- b) NEVER PICK UP A FLAMING PAN - You may be burned.
- c) DO NOT USE WATER, including wet dishcloths or towels - a violent steam explosion will result.
- d) Use an extinguisher ONLY if:
 - 1) You know you have a Class ABC extinguisher, and you already know how to operate it.
 - 2) The fire is small and contained in the area where it started.
 - 3) The fire department is being called.
 - 4) You can fight the fire with your back to an exit.

GROUNDING INSTRUCTIONS

This appliance must be grounded. In the event of an electrical short circuit, grounding reduces the risk of electric shock by providing an escape wire for the electric current. This appliance is equipped with a cord having a grounding wire with a grounding plug. The plug must be plugged into an outlet that is properly installed and grounded.

WARNING - Improper grounding can result in a risk of electric shock. Consult a qualified electrician if the grounding instructions are not completely understood, or if doubt exists as to whether the appliance is properly grounded. Do not use an extension cord. If the power supply cord is too short, have a qualified electrician install an outlet near the appliance.

NEVER CUT THE PLUG FROM THE ELECTRIC CORD AND ENSURE THE OUTLET IS GROUNDED, CUTTING THE CORD WILL VOID THE WARRANTY.

CHARACTERISTICS

DIMENSIONS

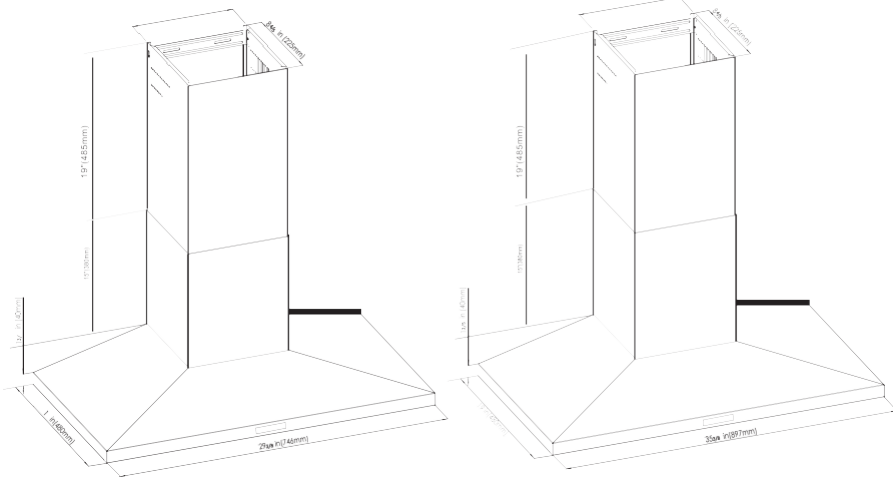
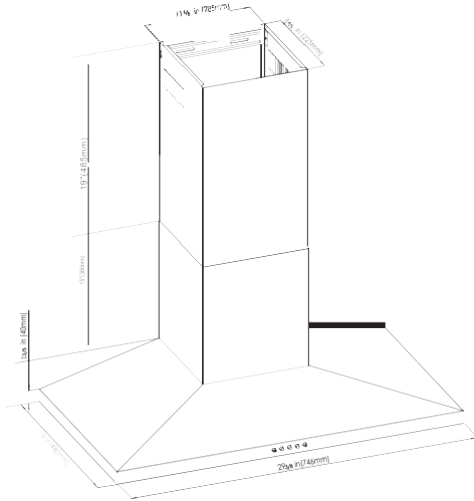

INSTALLATION & USE

USE ONLY WITH RANGE HOOD CORD CONNECTION KITS THAT HAVE BEEN INVESTIGATED AND FOUND ACCEPTABLE FOR USE WITH THIS MODEL RANGE HOOD.

Note 1 : On stainless steel hoods, carefully remove the plastic protective film from all exterior surfaces of the hood and chimney prior to final installation.

Note 2: At least two people will be required to mount the hood.

INSTALLTION DRILLING AND LINING

1. Draw a vertical line on the supporting wall up to the ceiling, or as high as practical, at the center of the area in which the hood will be installed.
2. Draw a horizontal line 28-30 inches above an electric hob or 30-32 inches above a gas hob.
3. Place chimney mounting brackets on the wall as shown about 1" (27mm) from the ceiling or upper limit aligning the center (notch) with the vertical reference line.

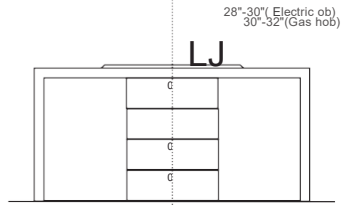
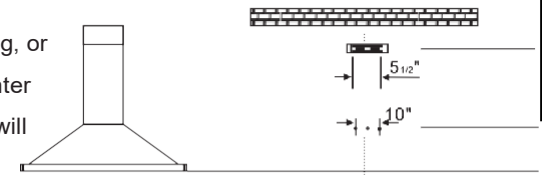

MOUNTING THE HOOD

1. Mount two main mounting screws into the wall along the line that is 10" above the horizontal line. To ensure that two screws are paralleling with horizontal line.
2. Hook the hood body on the wall by mounted screws and screw up the screws.
3. Mounting the auxiliary four screws to fix the hood body.

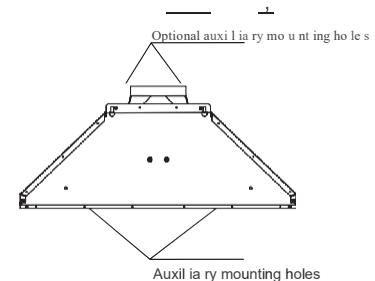
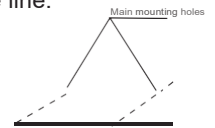

DUCT FIXING

Caution: To reduce the risk of fire, use metal ductwork only. (Metal duct should be sourced by locally.)

1. Attach an adequate length of 4" to 6" round duct on the top the outlet adapter.
2. Secure the duct using fastener. Make sure the duct is fixed well on.

TELESCOPIC CHIMNEY ASSEMBLY

Chimney Bottom

1. Carefully slide the chimney bottom down outside the chimney top partly, then carefully place the chimney bottom into the recessed area of the hood body top.

Chimney Top

1. Raise the chimney top up inside the chimney bottom. Secure the chimney top to the chimney mounting bracket that is well fixed on the wall with the two chimney bracket screws supplied from two sides.

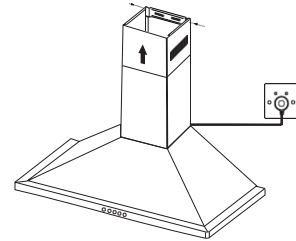
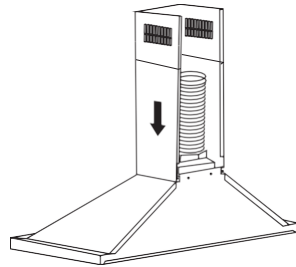

CONNECTIONS

Ducted mode air exhaust system

Caution: To reduce the risk of fire, use metal ductwork only. (Metal duct should be sourced by locally.)

1. Decide where the ductwork will run between the hood and the outside.
2. A straight, short duct run will allow the hood to perform most efficiently.
3. Long duct runs, elbows, and transitions will reduce the performance of the hood. Use as few of them as possible. Larger ducting may be required for best performance with longer duct runs.
4. Attach an adequate length of 4" to 6" round duct to the air outlet adapter.
5. The air must not be discharge into a flue that is used for exhausting fumes from appliances burning gas or other fuels" "Regulations concerning the discharge of

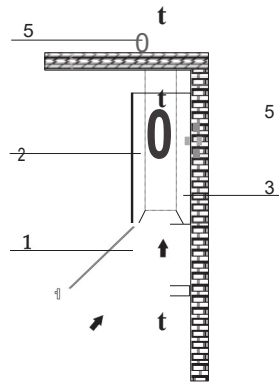

air have to be fulfilled.

6. Install a roof/wall cap. Connect round metal ductwork to cap and work back towards hood location. Use duct tape to seal the joints between ductwork sections.

Recirculation Mode

Caution: Do not use plastic or rigid metal ducting.

1. Install the charcoal filter on.
2. Please note that the air will flow out from the two grids on the two sides of the chimney top.

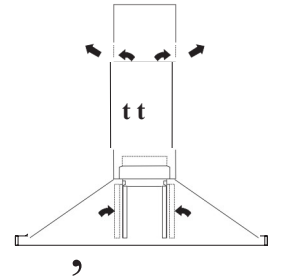

Electrical connection

- * Electrical wiring must be done by a qualified person(s) in accordance with all applicable codes and standards. **Turn off electrical power at service entrance before wiring.**
- * If the supply cord is damaged, it must be replaced by the manufacturer, its service agent or similarly qualified persons in order to avoid a hazard.
- * Do not use the plug and an extension cord other than the ones initially supplied with the hood.
- * The earthing of this hood is compulsory. Do not remove ground prong of the plug.

OPERATION OF CONTROLS

The hood is operated using the push button on the front panel.

The light switch turns the lamps on and off.

The blower switch turns the blower on to three speed settings:

- 0- OFF
- 1 - LOW SPEED
- 2 - MEDIUM SPEED
- 3 - HIGH SPEED
- 4- LIGHT

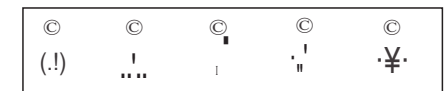

Off Low Mid High Light

The hood is operated by using F11 soft touch control (remote control is included)

SOFT TOUCH CONTROL SWITCH

The hoods may be operated using the soft touch control on the front panel.

The lights switch turns the lamps on and off.

The blower switch turns the blower on to three speed settings:

1 -Lamp

2 - PLUS





3 - MINUS

4- ON/OFF



5 - REMOTE CONTROL RECEIVER





How to set the clock



Press button  for 3 seconds, the time indicator in the display keep flashing, press button  and  to adjust hour setting, push button  again to set the minute setting. The machine will automatically confirm if without any operation in 3 seconds.

How to set timer delay

When the fan is working, press button  for 3 seconds, light the timer delay indicator in the display and time indicator keep flashing, Press button  and  to set the delay time range from 1min to 15mins. The machine will automatically confirm the setting if without any operation in 3 seconds.

Clean indicator function

After long time usage, If the symbol  in the display light, that indicates the grease filter reach saturation and need to wash. Keep pressing the  for 3 seconds to *remove* this symbol if the filter has been cleaned.

Note: The symbol  will keep lighting if without operation of keeping button  for 3 seconds

MAINTENANCE

GREASE FILTER

* The grease filters should be cleaned frequently (every two months of operation, or

more frequently for heavy use). Use a warm detergent solution.

* Grease filters are washable.

(1) PUSH DOWN

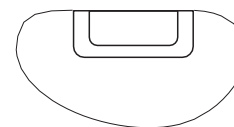

(2) LIFT OUT

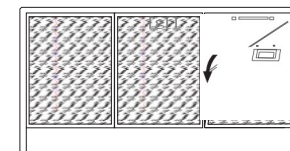

1. Remove the grease filter one by one by pushing down each latch. This will disengage the filter from the hood. Tilt the filter downward and *remove*.
2. Wash the filters, taking care not to bend them. Allow them to be dry before refitting.
3. When refitting the filters, make sure that the handle is visible from the outside.
4. To install the grease filter, align rear filter tabs with slots in the hood. Push down the latch, push filter into position and release. Make sure the filter is securely engaged after assembly.

NON-DUCTED RECIRCULATION CHARCOAL FILTER

This filter is not washable, cannot be regenerated, and should be replaced approximately every 3 months of operation, or more frequently in the case of heavy usage.

1. To install the charcoal filter and lock it until the stop click is heard.
2. Install grease filter after charcoal filter is installed.

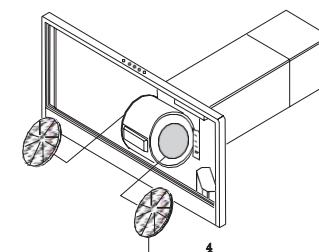

HALOGEN BULBS

This range hood may require two halogen bulbs (120V, GU10, SOW)

WARNING: Always switch off the electrical supply before carrying out any operation on the appliance.

To change bulbs:

1. Switch off power and wait for 5 minutes till the bulbs cool down.
2. Wear gloves and remove the bulb by pulling sideward (as the direction instructed).
3. Replace with 120V, GU10, 50W halogen bulbs.

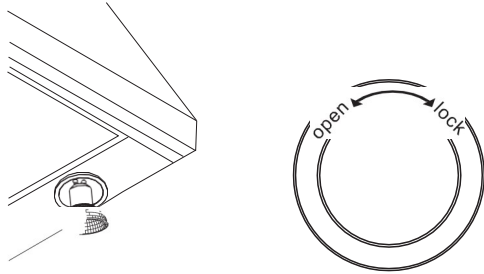

CAUTION:

1. THE SURFACE OF THE HALOGEN BULBS MAY BE HOT. TAKE CARE WHEN TAKING THE REPLACEMENT.

OIL CUP

1. To install the oil cup and lock it on to the motor blower.
2. The oil cup should be cleaned frequently. The oil accumulated inside the oil cup cannot be more than half. Use a warm detergent solution.
3. Allow it to be dry before refitting.

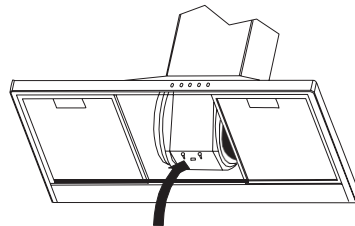

HOOD CLEANING

Stainless steel is one of the easiest materials to keep clean. Occasional care will help preserve its fine appearance.

Cleaning tips:

- * Hot water with soap or detergent is all that is usually needed.
- * Follow all cleaning by rinsing with clear water. Wipe dry with a clean, soft cloth to avoid water marks.
- * For discolorations or deposits that persist, use a non-scratching household cleanser or stainless-steel polishing powder with a little water and a soft cloth.

- * For stubborn cases use a plastic scouring pad or soft bristle brush together with cleanser and water. Rub lightly in direction of polishing lines or "grain" of the stainless finish. Avoid using too much pressure that may mar the surface.
- * Do not allow deposits to remain for long periods of time.
- * Do not use ordinary steel wool or steel brushes. Small bits of steel may adhere to the surface causing rust.
- * Do not allow salt solutions, disinfectants, bleaches, or cleaning compounds to remain in contact with stainless steel for extended periods. Many of these compounds contain chemicals that may be harmful. Rinse with water after exposure and wipe dry with a clean cloth.
- * Painted surfaces should be cleaned with warm water and mild detergent only.

Warranty

This product has been manufactured by BOURDEAU GRIFFIN, 8237 S. Princeton Ave. Chicago,

IL 60620. BOURDEAU GRIFFIN disclaims all express warranties except for the following:

This warranty applies to products purchased and located in the United States. Products purchased or located outside this area are excluded.

The warranty does not apply to damage resulting from abuse, accident, natural disaster, loss of electrical power to the product for any reason, alteration, outdoor use, improper installation, and improper operation, repair or service of the product by anyone other than an authorized BOURDEAU GRIFFIN, service agency or representative.

Warranties and Duration

Full warranty for Parts and Labor: first year parts.

Implied warranties terminate upon expiration of the limited warranty. Some states do not allow limitations on how long implied warranty lasts, so the above limitation may not apply to your implied warranty.

BOURDEAU GRIFFIN will pay for:

All repair labor and cost of replacement parts found to be defective due to material and workmanship. Service must be provided by a BOURDEAU GRIFFIN Authorized Service Agency during normal working hours.

For a Service Agency nearest you, please call 877-288-8099.

BOURDEAU GRIFFIN will not pay for:

This limited warranty does not cover:

1. Service to instruct you on how to use your Range Hood to correct house wiring, replace or repair house fuses, service to correct the installation of your Range Hood.
2. Repairs when your Range Hood is used for other than normal, single-family household use or when it is used in a manner that is contrary to published user or operator instructions and/or installation instructions.
3. Cosmetic damage, including chips, dents, scratches or other damage to the finish of your Range Hood, unless such damage results from defects in materials or workmanship and is reported to BOURDEAU GRIFFIN within 30 days from the date of purchase.
4. Costs associated with the removal from your home of your Range Hood for repairs. This Range Hood is designed to be repaired in the home and only in-home service is covered by this warranty.
5. Damage resulting from misuse, alteration, accident, abuse, fire, flood, acts of God, improper installation, installation not in accordance with electrical, or use of consumables or cleaning products not approved by BOURDEAU GRIFFIN.
6. Service to repair or replace consumable parts. Consumable parts are not included in the warranty coverage.

7. The removal and reinstallation of your Range Hood if it is installed in an inaccessible location or is not installed in accordance with published installation instructions.

8. This warranty is void if the factory applied serial number has been altered or removed from your Range Hood.

9. Repairs to parts or systems resulting from unauthorized modifications made to the appliance.

10. Expenses for travel and transportation for product service if your Range Hood is located in a remote area where service by an authorized BOURDEAU GRIFFIN servicer is not available.

The warranty applies to appliances purchased and used for personal, family or household purposes only. It does not cover appliances used for commercial applications.

Should the appliance be sold by the original purchaser during the warranty period, warranty shall extend to the new owner until the expiration date of the original purchaser warranty period.

Warranty and Product Registration

BOURDEAU GRIFFIN is not responsible for incidental or consequential damages. Under no circumstances will Thor Kitchen's liability exceed the cost that you paid for the product. Some states do not allow the exclusion or limitation of incidental or consequential damages, so the above limitations or exclusion may not apply to you.

This warranty gives you specific legal rights, and you may also have other rights that vary from state to state. Whenever you call our customer service at 877-288-8099 (THORKITCHEN Range Hood) for technical information and parts sales in the United States or to request service for your appliance, please have your complete model number and serial number ready. The model and serial number can be found on the product data plate. Please enter the information requested in the spaces provided.

Model No. _____ Serial No. _____

Date of Purchase _____ Purchaser _____

Dealer _____ Suburb _____

Town _____ Country _____

Note: You must provide proof of purchase and installation date for in-warranty service.